

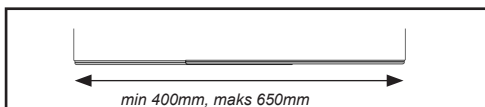

Stender-fix -montasjesystem for el-bokser

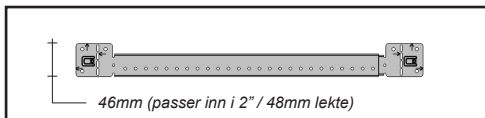
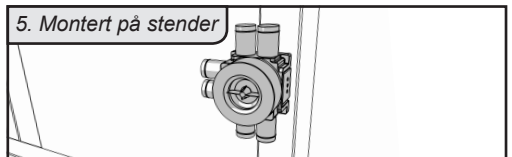
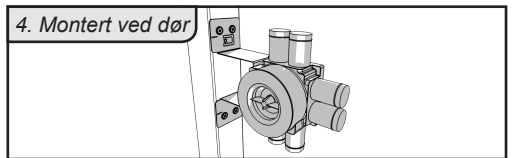
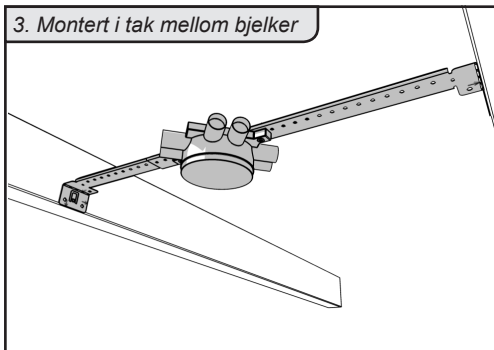
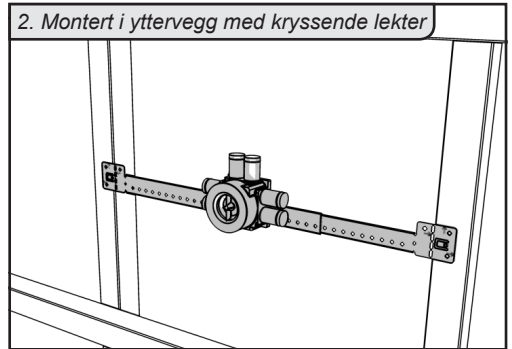
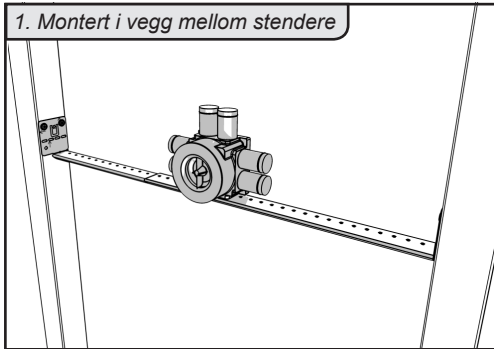

Teleskop

EL.NR 13 428 15

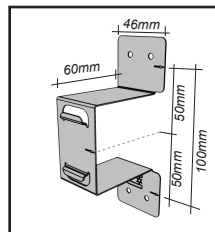

Brakett

EL.NR 13 428 16

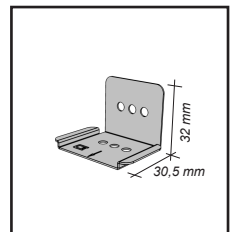

Skive

EL.NR 13 428 17

1. TELESKOP

Montert i vegg mellom stendere

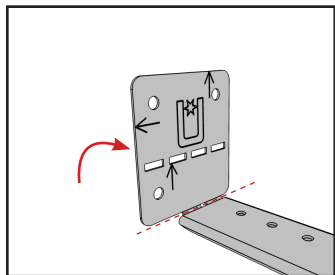

Knekk opp i 90 grader.

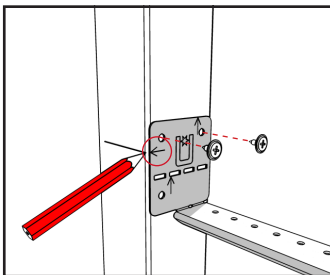

Indikert pil markerer hvor boksens senter vil være. Monteres i kant på stender og skrues fast i begge sider.

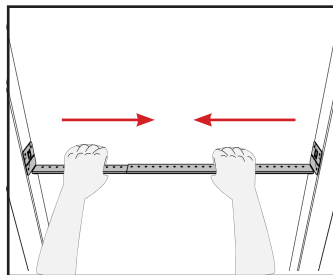

Juster teleskopet slik at hullene kommer ovenfor hverandre.

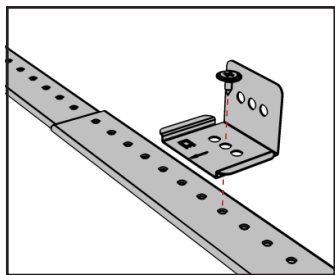

Monter Skive (EL NR.13 428 17) på teleskopet med Ø 4,2mm skruer.

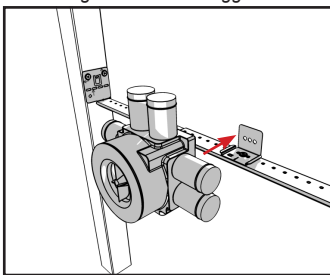

Skyv på El boks.

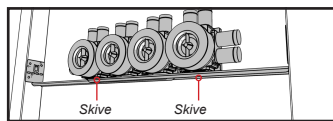
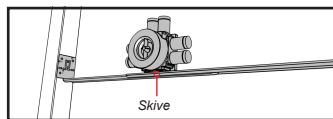

Eksempler sammenkoblinger.

2. TELESKOP

Montert i vegg med kryssende 2" (48mm)lekker

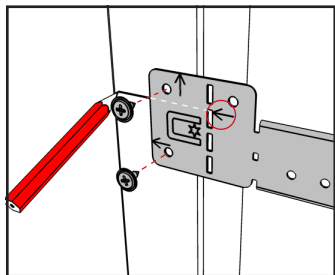

Indikert pil markerer sentermål av boksen.

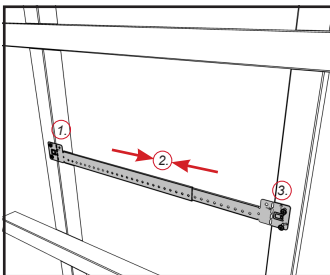

1. Skru fast. 2. Juster så hullene er ovenfor hverandre. 3. Skru fast andre siden.

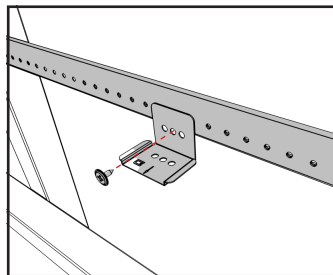

Monter skive EL.NR 13 428 17 med Ø 4,2mm skruer. Pass på eventuell plast i bakkant.

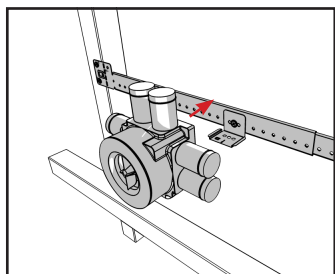

Skyv på el boks.

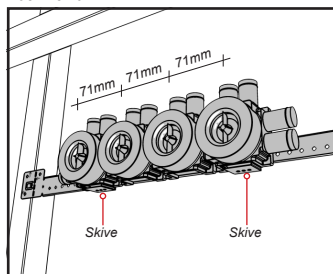
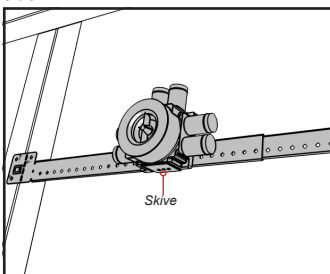

Eksempler m/sammenkoblinger.

3. TELESKOP

Montert i tak mellom sperrer

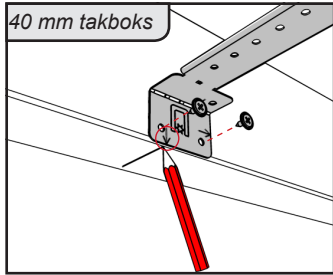

Ved bruk av 40 mm takboks, knekk som anvist og monter "kant i kant".

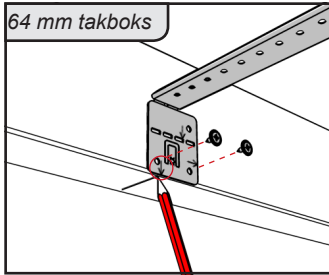

Ved bruk av 64 mm takboks, knekk som anvist og monter "kant i kant".

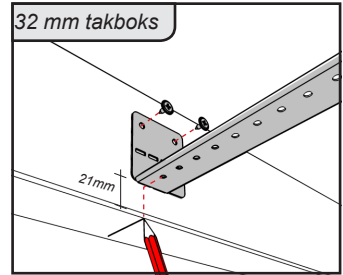

Ved bruk av 32 mm takboks, knekk som anvist og monter 21mm fra underkant sperre.

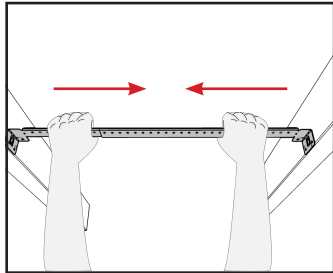

Juster teleskopet slik at hullene kommer ovenfor hverandre.

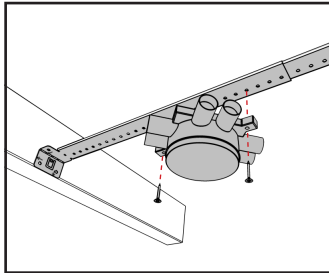

Skrue fast takboksen med \varnothing 4,2mm skruer.

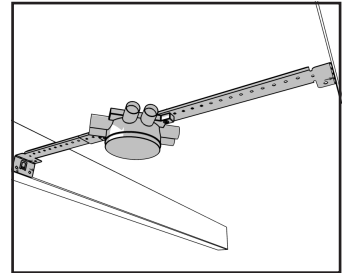

4. BRAKETT

Montert ved dør for å unngå konflikt med dørlister

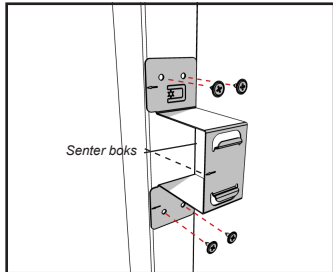

Monter braketten i flukt med stenderen med pilene pekende mot deg.

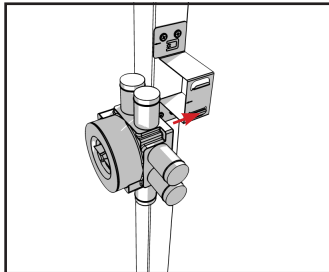

Skyv på ei boksen.

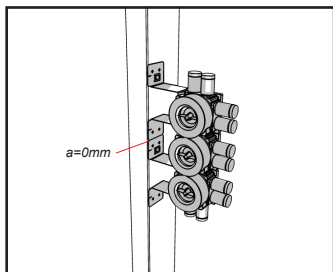
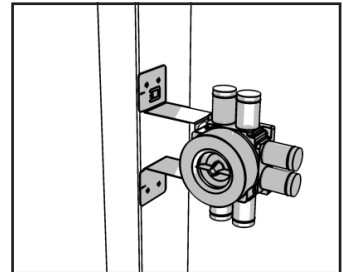

Brakettene står med avstand=0 ved 3 sammenkoblede bokser.

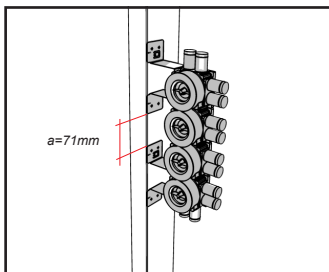

Brakettene står med avstand=71 ved 4 sammenkoblede bokser.

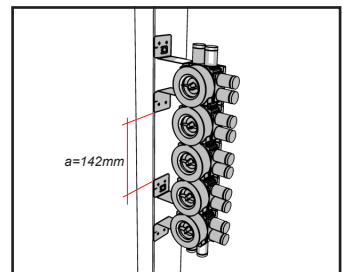

Brakettene står med avstand=142 ved 5 sammenkoblede bokser.

5. SKIVE

Montert direkte på stender

Sidemontert på stender

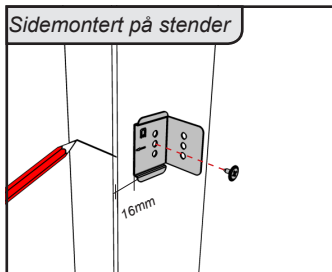

Monter skiven på siden av stenderen med avstand 16 mm fra kanten. Pilen peker utover.

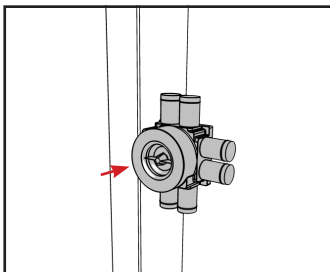

Skyv på el boks.

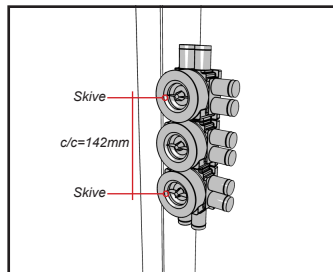

Eksempel sammenkobling.

Kryssende 2" (48mm) leker

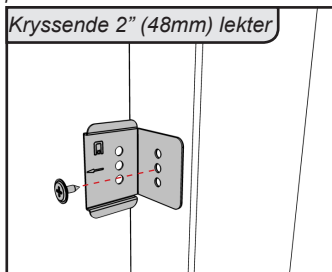

Monter skive som vist på illustrasjonen.

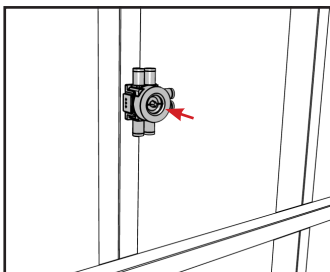

Skyv på el boksen.

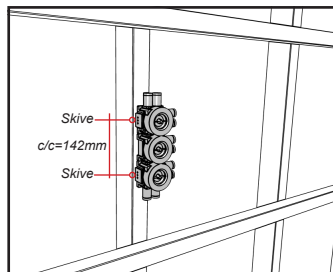

Eksempel sammenkobling.



Castor AS
Postboks 405, Brakerøya
3002 Drammen

Besøksadresse:
Nøsteveien 76
3402 Lier

Tel: +47 32 24 21 00
Fax: +47 32 24 21 01
mail@castoras.no

castoras.no